

Aluminium ANODE ZC70-4

gross weight: 12,40 kg
nett weight: 10,10 kg

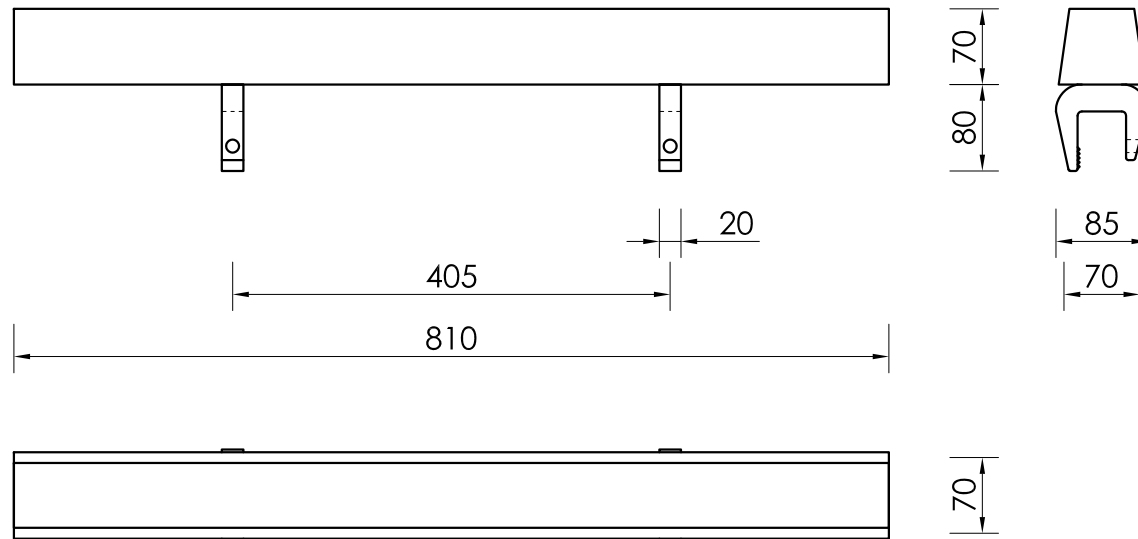

Technical specification AlZnIn - alloy type A2 according to EN12496:2013 :

Alloying elements:		Impurities:	
Zn [%]:	3,0 - 5,5	Fe [%]:	max 0,09
In [%]:	0,016 - 0,040	Cu [%]:	max 0,005
Al -	balance	Si [%]:	max 0,10

Electrochemical efficiency min: 2500 Ah/kg
according to DNV RP B401 test appendix B

Note:

- All weights and dimensions are nominal.
- Dimensions in mm

 MAKROMOR CATHODIC PROTECTION	MAKROMOR SP. Z O.O. Ul. Gołębia 15 81-185 Gdynia, POLAND Phone: +48 58 661-57-99 Fax: +48 58 661-01-89 e-mail: biuro@makromor.pl website: www.makromor.pl	Scale:	1:7,5
		Insert type:	S235JR
		Alloy:	AlZnIn
Type:		Alternative type:	
ALUMINIUM TANK ANODE ZC70-4			
Product code:		Drawing No.:	
A124/ZC70/70/70/810/405/0		AZC704/0	
Drawer:	Date:	Approved:	Date:
Ewa Nawrocka	18-04-2013	Grzegorz Pryłowski	19-04-2013
Copyright MAKROMOR SP. Z O.O. All rights reserved.			